

# eZDeposit

*User's Starter Kit*

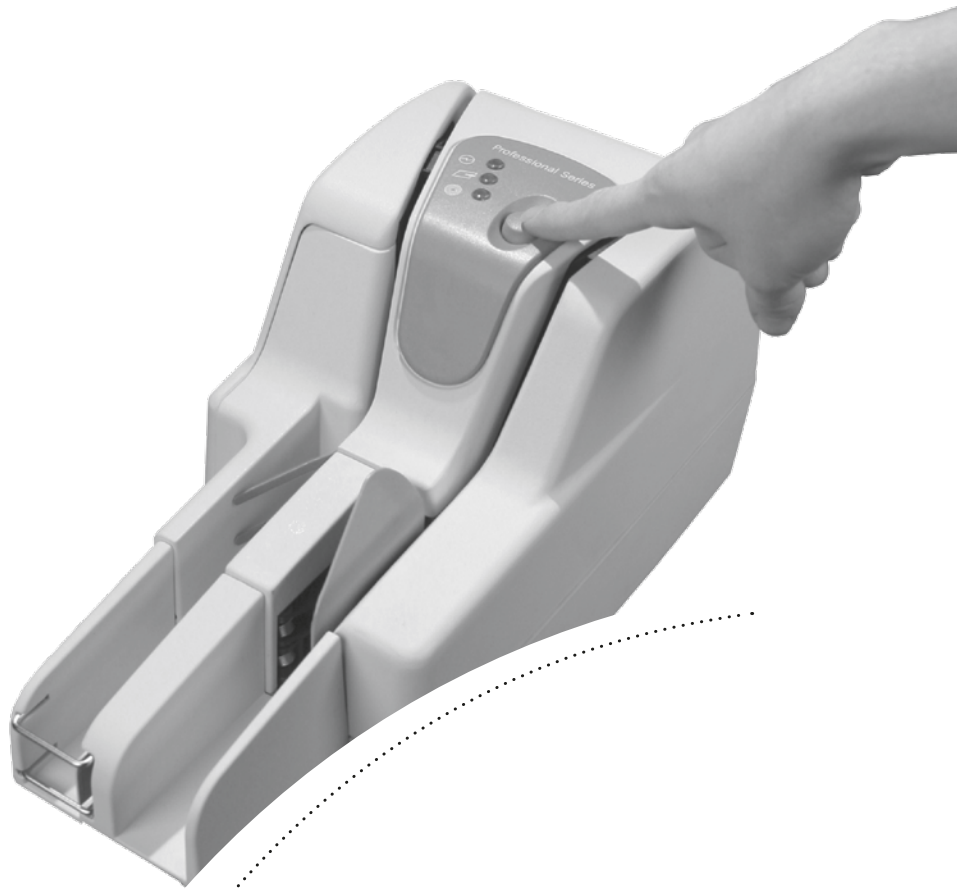

[www.firstmontanabank.com](http://www.firstmontanabank.com)



## Table of Contents

- 2 About eZDeposit
- 5 eZDeposit FAQs
- 9 Your Rights & Obligations
- 13 Security & Privacy Issues
- 19 Scanner & Software Information
- 23 Customer Notification
- 27 Definitions

# Welcome to eZDeposit

---

eZDeposit utilizes a desktop check scanner that connects to your PC and the Internet. With it, you can scan checks received from customers and issue deposits electronically to your financial institution, anytime day or night. It's the fastest way to turn check deposits into cash. This User's Starter Kit is designed as a convenient quick-reference guide to get you started quickly.

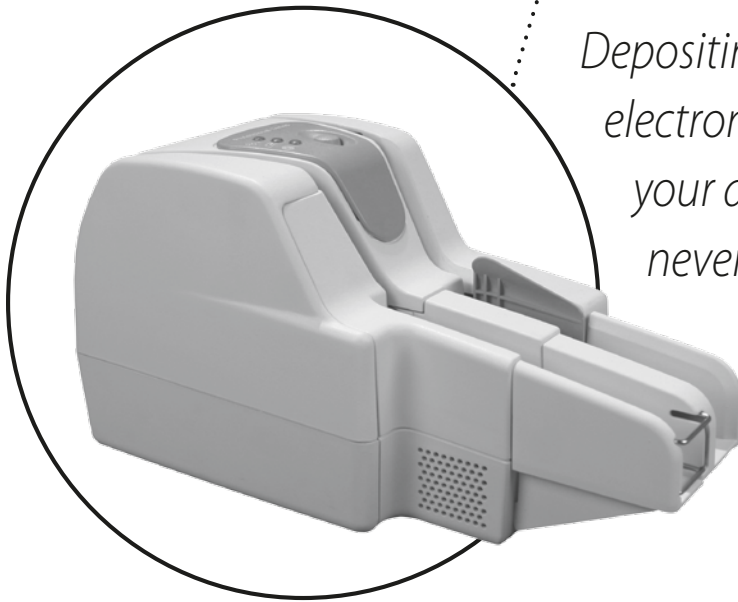

*Depositing checks  
electronically from  
your desktop has  
never been easier.*

# eZDeposit Features

---



## **Consolidate funds from remote locations into one financial institution**

Check deposits can easily be made from any remote office or storefront. This streamlines your cash flow by consolidating deposits from multiple locations into a single financial institution.



## **Make deposits anytime**

Enjoy the convenience of making deposits electronically 24 hours a day, 7 days a week, even on weekends and holidays.



## **Cut costly courier fees or trips to your financial institution**

Electronic deposits can reduce trips to the financial institution, saving on fuel costs and reducing or eliminating costly courier fees.



## **Save time preparing deposits**

Preparing deposits electronically is very efficient, reducing labor costs and freeing up staff for other tasks.



## **Reduce risk of check fraud**

Faster check clearing allows you to react sooner on returned checks, significantly increasing your opportunities for collection.



## **More secure**

eZDeposit features multiple layers of security including password protection, Internet firewalls, and 128-bit encryption, the highest level of security available.

---

# How Does eZDeposit Work?

---

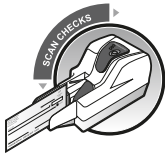

## Scan checks from your desktop.

Using a supported check scanner, simply scan both sides of the checks in a single pass.



## Prepare the deposit.

View images of the scanned checks right from your PC. The dollar amounts for the checks are automatically read and the deposit is totaled.



## Electronically send the deposit to your financial institution.

Click **SUBMIT DEPOSIT** and that's it. The deposit is sent to your financial institution through a secure Internet connection.



## Funds are deposited into your account.

Access funds sooner than traditional deposits. Note that deposits to your account are usually processed by the financial institution during normal business hours.

## Check 21

eZDeposit is a result of the Check 21 legislation enacted in 2004. This law allows for electronic images of checks to be accepted as the legal equivalent of original paper checks. As a result, you can remotely capture checks and send a batch of electronic images to the financial institution for processing.

Customers may receive an image of the check in their financial institution statement. When needed, a paper image called a substitute check can be reproduced. Both image checks and substitute checks are accepted as legal proof of payment.

To learn more about Check 21 visit the Federal Reserve's Website at [www.federalreserve.gov/pubs/check21/shouldknow.htm](http://www.federalreserve.gov/pubs/check21/shouldknow.htm)

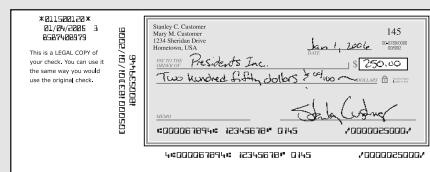

*Substitute checks are the legal equivalent of original paper checks.*

# eZDeposit FAQs

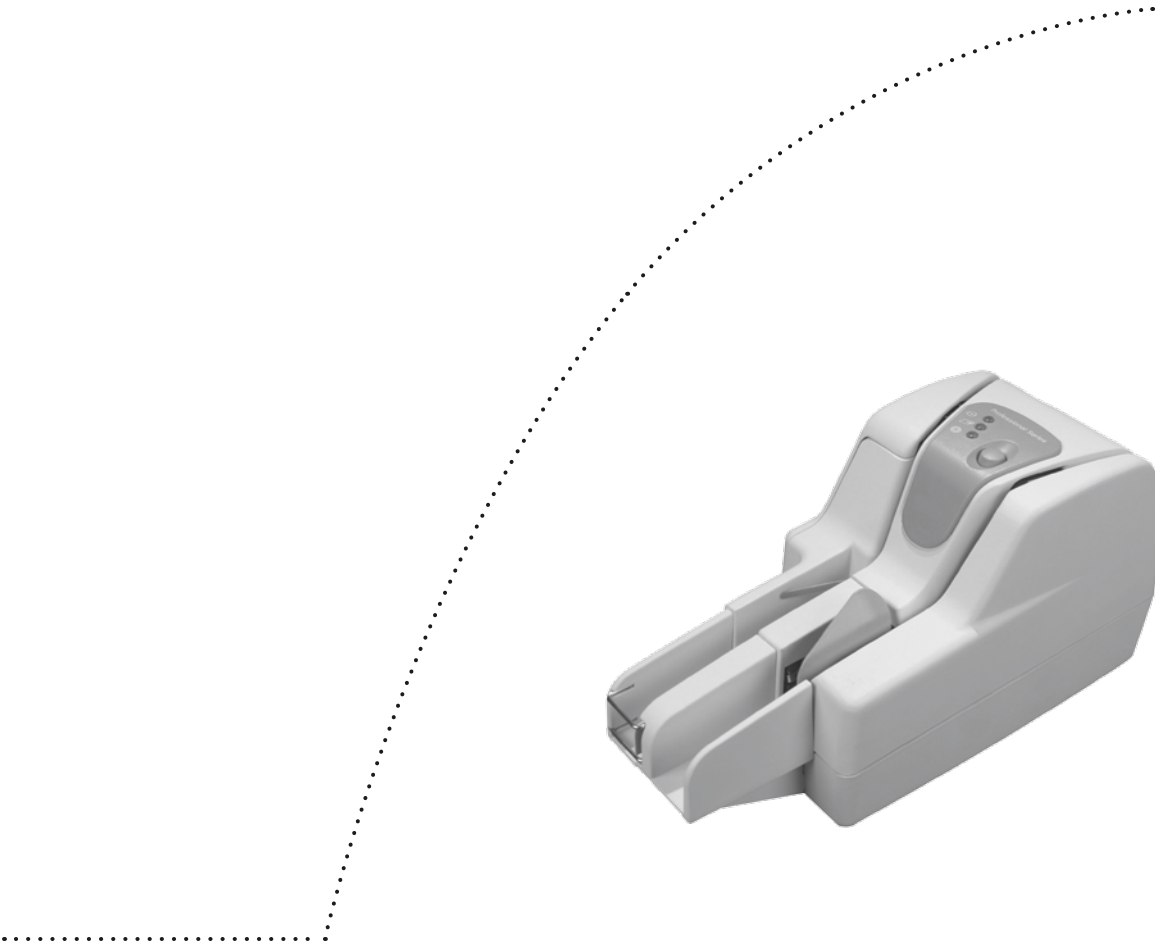

# eZDeposit FAQs

---

## **What types of checks can be processed through eZDeposit?**

All personal and business U.S. checks can be processed through eZDeposit. Checks from Canada and other foreign countries, food stamps, savings bonds and poor image quality checks must be deposited traditionally.

## **How secure is eZDeposit?**

eZDeposit features multiple layers of security including password protection, Internet firewalls, and 128-bit encryption, the highest level of security available.

## **What do we need to use eZDeposit?**

- PC with a current version of Windows 2000®, Windows XP® or Windows Vista® (32-bit)
- Approved desktop check scanner connected to the PC
- High-speed Internet connection
- Account with the financial institution
- Internet Explorer® 6 or newer

## **Are there any deposit limitations using eZDeposit?**

There may be limits on the number of deposits per day, and/or the total dollar amount of deposits.

## **Can the deposit history be viewed within eZDeposit?**

The deposit history can be viewed within eZDeposit as far back as the financial institution has determined to retain the images. History prior to that must be accessed through Internet Banking.

## **What type of Internet connectivity is needed?**

A Broadband or DSL-type connection is recommended.

## **When will deposits be posted to our account?**

Deposits submitted through eZDeposit will be posted on the current or next business day depending on when they are received. In some cases, the window for processing electronic deposits may be extended beyond the hours for traditional paper deposits.

---

**Questions?**

*Contact the financial institution for further details.*

---

**How do we prevent checks from being scanned and deposited twice?**

The software is designed to compare each check to the previous checks you have deposited. If a possible duplicate item is found, you will be alerted and corrective action will need to be taken.

**How do we know if the image quality is acceptable?**

The software uses a process called Image Quality Analysis (IQA) to determine if all required information from the check is readable. If the check image fails IQA, you'll be alerted. For more information about check image quality, see "Scanning Checks" on Page 21.

**When can electronic deposits be issued to the financial institution?**

You can submit electronic deposits to the financial institution 24 hours a day, 7 days a week, including weekends and holidays with the exception of the financial institution's routine maintenance downtime. The financial institution's business day for processing electronic deposits may also be extended. Contact your financial institution for details.

**What should we do with the original paper checks after deposits are made?**

Original checks should be stored for a minimum amount of time prior to being destroyed, as determined by your financial institution. Your company will need to set policies for the proper storage and methods for securely destroying the original paper checks. Included in this booklet are guidelines to assist you in the development of these policies.

**Who should use the system?**

Individuals already in charge of manually preparing and delivering deposits are typically the same people who will use eZDeposit.

---





**Notes:**

Notes section with 20 horizontal lines for writing.

---

---

---

---

---

---

---

---

---

---

---

---

---

---

---

---

---

---

---

---

---

---

---



# Your Rights & Obligations

---



# Your Rights & Obligations

---

Prior to using eZDeposit , an application and other compliance forms will need to be completed and approved by your financial institution. It is recommended that you keep these forms on hand for future reference.

## **Your Obligations**

As an eZDeposit user you guarantee the following:

- The check images presented to the financial institution accurately represent all information on both sides of the check.
- The check images contain all endorsements.
- Checks are kept in a safe and secure area.
- Checks are to be destroyed in accordance with financial institution instructions.
- Checks can only be deposited once.
- Checks are voided after deposit verification on statement.
- Original items will be provided to the financial institution upon request.

## **Equipment**

Use only supported equipment. Do not bypass, override or disable any security mechanisms within the equipment.

## **Maintenance of Equipment**

Make sure your equipment is clean and operating properly. Periodically inspect and verify that the images are legible.

## **Storage and Destruction of Checks**

It is important to retain the original paper checks for a period of time, as described in your eZDeposit Agreement. After the retention period expires, you are required to use an acceptable method to securely destroy all original paper checks.

## **Acceptance of Deposit**

The financial institution will accept electronic check images for deposit into your account upon receipt of a successful transmission of check images. Deposits must be complete, usable, and adhere to data specifications established by the financial institution.

---

---

### **Returned Items**

If a financial institution returns an item you captured, the financial institution may charge your account for the item. The financial institution may also:

- Provide a returned item notification and/or substitute check copy to you.
- Or re-present the check to the financial institution for payment.

### **Breach of Information**

As the financial institution, we may suspend your eZDeposit service if we have reason to believe there has been:

- A breach in the security of the program.
- Fraud involving a customer's account or their check.
- Uncertainty regarding the authorization or accuracy of electronic items.

### **Following the Law**

You are expected to comply with the terms of the eZDeposit Agreement as well as all applicable federal, state and local laws and regulations.

### **Copyright Information**

**eZDeposit is copyright protected and prohibits the following:**

- Copy or use of the system software or documentation except as expressly authorized.
- Sublicense, rent, distribute, transfer, publish, disclose, display or otherwise make the system software available to others.
- Use of the system software or documentation for third-party training, commercial time-sharing or service bureau use.
- Alter, change, modify or otherwise create derivative works of the system software or documentation. Refer to the user agreement for additional restrictions.



**Notes:**

---

---

---

---

---

---

---

---

---

---

---

---

---

---

---

---

---

---

---

---

---

---

---

---



# Security & Privacy Issues

---



## Security & Privacy Issues

---

Security and privacy issues are important considerations when using eZDeposit. This chapter offers guidelines for setting your company's policies and procedures for the proper storage and disposal of customers' checks and personal information.



---

### **Guidelines for Securely Storing Checks**

eZDeposit requires users to store the original checks for a minimum amount of time prior to destroying them. Due to privacy laws and the liabilities associated with the storage of original checks, here are a few important measures you should take:

- ❶ Store all original checks in a safe or lockbox, accessible only by authorized personnel.
- ❷ Do not store customer account information, photocopies, or private information in your general files which are accessible to non-authorized personnel.
- ❸ Maintain a filing system that easily identifies any missing checks. Suggestions include:
  - a. Store the checks in chronological order so you can destroy checks in accordance with your financial institution policies.
  - b. Maintain an accurate count of checks you have stored at any time.
- ❹ Set a timetable for periodic destruction of stored original checks.
- ❺ Maintain a paper shredder on-site or hire a third-party service for the secure destruction of checks.
- ❻ Have a locked or secure trash bin for the disposal of shredded checks.
- ❼ Guidelines for protecting access to eZDeposit include:
  - a. Computers should have working anti-virus software and software should be regularly updated.
  - b. Limit access to eZDeposit to authorized personnel only and require a login with user ID and password for access.
- ❽ Perform routine audits for potential security breaches to customers' information.



---

### **Use of Customer Information**

Since you may have access to personal information regarding your customers, you are required to:

- Maintain the confidentiality, integrity and security of their information.
- Use customer information only for the purposes as described in the eZDeposit Agreement.
- Disclose such information only to authorized personnel.
- Maintain physical, technical, procedural and administrative procedures reasonably designed to ensure the security, integrity and confidentiality of customers' information.

### **Breach of Information**

The financial institution may suspend your eZDeposit services if the financial institution has reason to believe there has been:

- A breach in the security of the program.
- Fraud involving a customer's account or their check.
- Uncertainty regarding the authorization or accuracy of electronic items.

### **Proper Disposal of Checks**

After the storage period has expired, all paper checks must be destroyed using a secure, approved method:

- Set a timetable for periodic destruction of stored paper checks.
- Use a paper shredder or other approved methods for the secure destruction of paper checks.

**⚠ IMPORTANT!**

*If a breach of security is discovered, immediately contact local authorities, your financial institution, and customers that may have had their information compromised.*

---

## Check Fraud Prevention

### Accepting Checks

Always have your check cashing procedures clearly defined. The following safety precautions can help prevent check fraud:

- Ask for a picture ID before accepting checks.
- Always make sure the customer signs the check in front of you.
- Request that checks be written with blue or black ink.
- The check's MICR line should appear slightly raised and not smudged.
- Don't accept starter checks, or checks without a financial institution logo and routing number.
- Be alert to suspicious or unusual activity when accepting checks.
- Two-party checks double the risk for check fraud.



### Detecting a Fraudulent Customer

Here are a few tips to spot customers who may be attempting to pass a fraudulent check.

- Makes random purchases without paying attention to size, value or price.
- Presents you with a check taken from a pocket instead of a checkbook or wallet.
- When asked for photo ID, claims to have left it at home or in the car.
- Arrives at or about closing time and tries to hurry you through the sale.
- Purchases a large item and refuses delivery.
- Displays no interest in the warranty on expensive items.
- Is overly slow and deliberate when signing the check, perhaps because the signature is being forged.
- Does not make eye contact with you.
- Is overtly friendly or overly rude in an attempt to distract you.



# Scanner & Software Information

---



# Scanner & Software Information

---

## Basics of the Scanner

eZDeposit works with approved scanners available from your financial institution.

## How the Scanner Captures an Image

Most check scanners capture an image of both sides of the check in a single pass. They also capture all data from the check including the MICR line, account & routing numbers, payee, signature, amount, date, and endorsements.

Supported scanners include Courtesy Amount Recognition (CAR) and Legal Amount Recognition (LAR) capabilities that read the customer's handwriting and automatically inputs the dollar amount of each check into the deposit. The scanned deposit total should be verified prior to sending it to the financial institution.

*Note: Scanners should be placed at least 18 inches from other electronic equipment.*

## System Requirements Checklist



### System Requirements

- PC with a current version of Windows 2000®, Windows XP® or Windows Vista® (32-bit), and Internet Explorer® 6 or newer.
- Supported desktop scanner connected directly to the PC.
- High-speed Internet connection.
- Account with the financial institution.

After logging on, the system automatically checks your computer to see that all the necessary components are working properly. It tests for the proper operating system, browser type, and other applications or settings. If a warning sign appears in the test, simply follow the on screen instructions to correct the error.

## Scanner and Software Installation

Check scanners are delivered from the manufacturer with instructions for installing the appropriate drivers.

---

---

## Scanning Checks

Check image quality is required to meet certain specifications including:

- Checks should be written in blue or black ink.
- Handwriting must be legible.
- The MICR line must appear to be fully intact.
- Checks must be signed.

The built-in Image Quality Analysis (IQA) tool will identify most checks with poor image quality, however, the guidelines listed above will help ensure checks are scanned properly. If the image fails the IQA test after scanning, review the following:

- Verify that the check was able to pass through the scanner.
- Make sure the information on the check is legible.
- Verify that the image displays the MICR line, signature, date, payee, amount, and both sides of the check.

Rescanning a check with poor check image quality may solve the problem. If the image quality problem persists, you may need to deposit the paper check at your financial institution.

## Caring for the Scanner

You can extend the life of your scanner by performing the following preventative maintenance procedures:

- 1 Complete a monthly “health check” of your scanner’s replaceable parts (including cartridge, absorbing felt, ink rollers, stamp pads, and lens cover) and replace them before they show extreme wear. Replacement instructions are described in the scanner’s instruction manual.
- 2 Do not insert checks that could damage the scanner, such as stapled checks.
- 3 Use compressed air to clean the scanner frequently. This eliminates dust and paper fragments that may damage the scanner.
- 4 Approximately every six months perform a general visual check and conduct simple testing to ensure the movement and tension of the scanner’s rollers and belts are sound. Adjust the parts as described to prevent possible malfunction.
- 5 Your preventative maintenance schedule may vary depending on frequency of use and your operating environment.

*Note: For more preventative maintenance hints refer to your scanner’s instruction manual.*

---

## Key Features of eZDeposit

---

- **Automatic:** The system can read the customer's handwriting and automatically fills in the amount of the check for the deposit.
- **Duplicates:** The system at your financial institution will review all deposits to ensure that no check is scanned or deposited twice.
- **Image Quality Analysis:** The IQA tool confirms the presence of the date, signature, payee, and the overall quality of the image.
- **No software to install:** Web-based system does not require installation or updating of software.
- **Totals the Deposit:** The system automatically totals the amounts.
- **Balances the Deposit:** The system will require and assist in balancing the transaction prior to submission.
- **Secure:** Uses the highest level of security available for sending electronic deposits to your financial institution.

# Customer Notification

---





# Customer Notification

---

With eZDeposit, your customers will no longer receive their original checks returned from their financial institution. Instead, they may receive an image of the check or a substitute check, or the check may be truncated. For this reason, you may want to notify customers about the change to your check processing procedures. A notification can be mailed to customers or displayed in prominent locations.

## **Sample 1:**

### IMPORTANT BILLING CHANGE

Effective Monday XX, XXXX (Company) will begin processing checks received for payment electronically. This means we will send an image of each check to the financial institution for processing rather than the original check.

#### How will this change affect me?

If you currently have checks returned in your financial institution statement, then you will continue to receive either an image of the check or a printed substitute check. Both are acceptable as legal proof of payment.

#### What happens to my original check?

Original checks will be securely stored for XX days and then destroyed. The image check or a substitute check will always be available from your financial institution for legal proof of payment.

What other payment options are available? (Company) will continue to accept credit card payments or call (800) XXX-XXXX for other payment options.

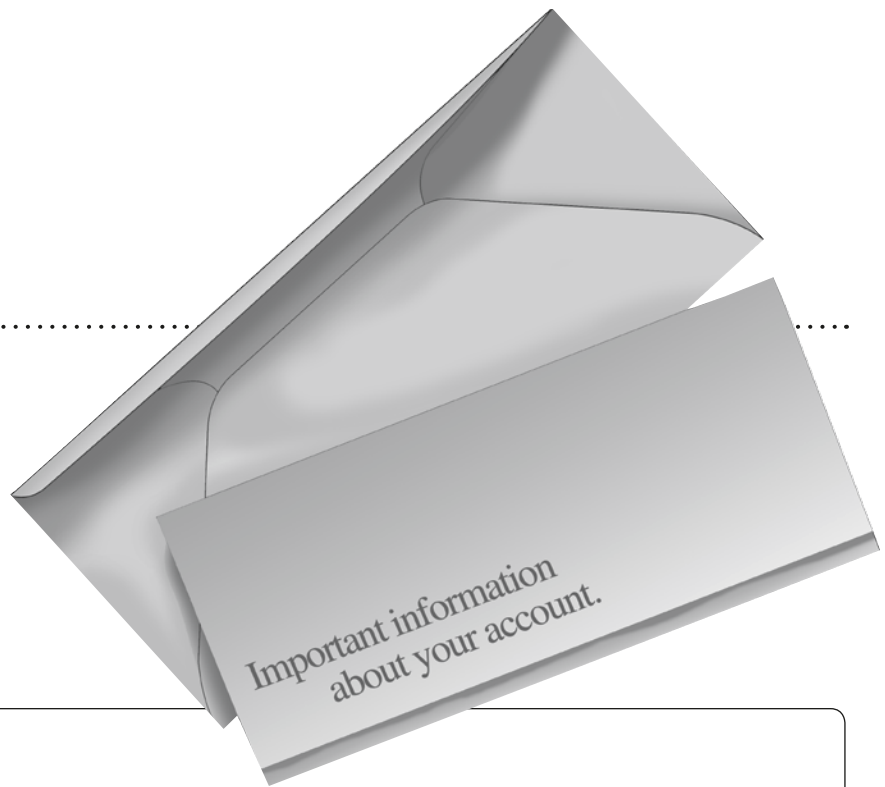

**Sample 2:**

Effective with your next payment, (Company) will process checks electronically. This means we will send an image of each check to the financial institution for processing rather than the original check. If you have questions please call (800) XXX-XXXX.

**Sample 3:**

Effective with your next payment, (Company) will process checks electronically. This means we will send an image of each check to the financial institution for processing rather than the original check. Original checks will be securely stored for XX days and then destroyed. The image of the check or a substitute check will always be available from your financial institution. (Company) will continue to accept credit card payments or call (800) XXX-XXXX for other payment options.



# Definitions



# Definitions

---

Use this as a handy quick-reference guide. It includes definitions for many of the terms you'll be using with eZDeposit .

**Account:** Account at the financial institution into which checks transmitted electronically will be deposited.

**Account Agreement:** The financial institution's standard deposit agreement and disclosures governing the account.

**ACH:** Acronym for Automated Clearing House, is a term that is often confused with eZDeposit . eZDeposit converts checks into an electronic image and is processed similar to a traditional paper check. An ACH payment converts a check into an electronic debit where the money is withdrawn from the customer's account immediately.

**Cash Management:** In this manual, cash management refers to the financial institution's Business Internet Banking system.

**Check:** A draft that is payable on demand, drawn on or payable through or at an office of a United States financial institution and payable or endorsed to customer. Types of checks include original checks, image checks, and substitute checks.

**Check 21:** Legislation passed in 2003 and became effective October 28, 2004. Allows for an electronic image to be accepted as the legal equivalent of the original paper check.

**Consumer Information:** Any record about an individual, whether in paper, electronic, or other form, that is a consumer report or is derived from a consumer report. Excludes information that does not identify individuals such as aggregate information or blind data.

**Dispose:** To discard or abandon consumer information, or the sale, donation, or transfer of any medium, including computer equipment, upon which consumer information is stored.

**Documentation:** All manuals and instructions relating to the program or the authorized equipment.

**Electronic Item:** A digital image of a check, an image exchange item, or any other electronic version of a check or other electronic item (such as items processed through the automated clearing house [ACH] system).

---

.....

**Image Check:** A paper reproduction of the electronic check, and is a legal proof of payment.

**Image Exchange Item:** A digital image of a check cleared and settled directly with a payor financial institution without conversion to a substitute check.

**IRD:** Another term for “substitute check”. IRD stands for Image Replacement Document. Once customer’s checks are scanned, and the images are sent to the financial institution, customers will no longer have access to the original check. So instead of receiving their original check they will receive an IRD or an image of the check. In most cases customers won’t see any significant differences in their statements.

**MICR:** The MICR line, or Magnetic Ink Character Recognition, contains the issuing financial institution’s transit number, check number, and account number on the bottom of the check.

**Non-cash Item:** An item that would otherwise be a check, except that:

- A passbook, certificate or other document is attached.
- It is accompanied by special instructions such as a request for special advice of payment or dishonor.
- It consists of more than a single thickness of paper, except a check that qualifies for handling by automated check processing equipment.
- It has not been preprinted or post-encoded in magnetic ink with the routing number of the payor financial institution.

**Original Check:** The first paper check issued for a payment transaction.

**Program:** The procedures, protocols, and software used by the financial institution and its licensors and contractors in connection with the electronic processing of checks, and includes the software and the services.

**Scanner:** A hardware device that scans the front and back of the check providing an image of the check.

**Services:** The services described by the financial institution, an agent, or designee of the financial institution, to enable eZDeposit users to process checks digitally and through substitute checks.

**Substitute Check:** A paper reproduction of an electronic check. A substitute check is the legal equivalent of the original check.

.....

# eZDeposit



**ANACONDA  
DOWNTOWN**  
123 Main St.  
406-563-8303

**ANACONDA EAST**  
1121 E. Park Ave.  
406-563-8304

**BOZEMAN**  
1336 Stoneridge Dr.  
406-587-2227

**BUTTE**  
1940 Dewey Blvd.  
406-494-6111

**KALISPELL**  
85 N. Main St.  
406-755-9999

**LIBBY**  
504 Mineral Ave.  
406-293-0280

**MISSOULA  
DOWNTOWN**  
201 N. Higgins Ave.  
406-829-2666

**MISSOULA BROOKS**  
3309 Brooks Ave.  
406-829-2640

**CORPORATE OFFICE**  
211 N. Higgins, Ste. 202  
402-829-2668

**TROY**  
600 E. Missoula Ave.  
406-295-5238



[www.firstmontanabank.com](http://www.firstmontanabank.com)

Member FDIC  Equal Housing Lender